

GP1S51VJ000F

Gap : 3mm Slit : 0.5mm
Phototransistor Output,
Case package Transmissive
Photointerrupter



■ Description

GP1S51VJ000F is a standard, phototransistor output, transmissive photointerrupter with opposing emitter and detector in a case, providing non-contact sensing. For this family of devices, the emitter and detector are inserted in a case, resulting in a through-hole design.

The case includes additional screw fixing holes, on both sides 3.2mm diameter.

■ Features

1. Transmissive with phototransistor output
2. Highlights:
 - Vertical Slit for alternate motion detection
 - Includes additional screw fixing holes
3. Key Parameters:
 - Gap Width : 3mm
 - Slit Width (detector side): 0.5mm
 - Package : 12.2×10×18mm
4. Lead free and RoHS directive compliant

■ Agency approvals/Compliance

1. Compliant with RoHS directive

■ Applications

1. General purpose detection of object presence or motion.
2. Example : Printer, FAX, Optical storage unit

Notice The content of data sheet is subject to change without prior notice.
In the absence of confirmation by device specification sheets, SHARP takes no responsibility for any defects that may occur in equipment using any SHARP devices shown in catalogs, data books, etc. Contact SHARP in order to obtain the latest device specification sheets before using any SHARP device.

■ Internal Connection Diagram

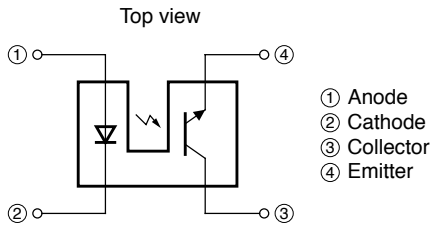

■ Outline Dimensions

(Unit : mm)

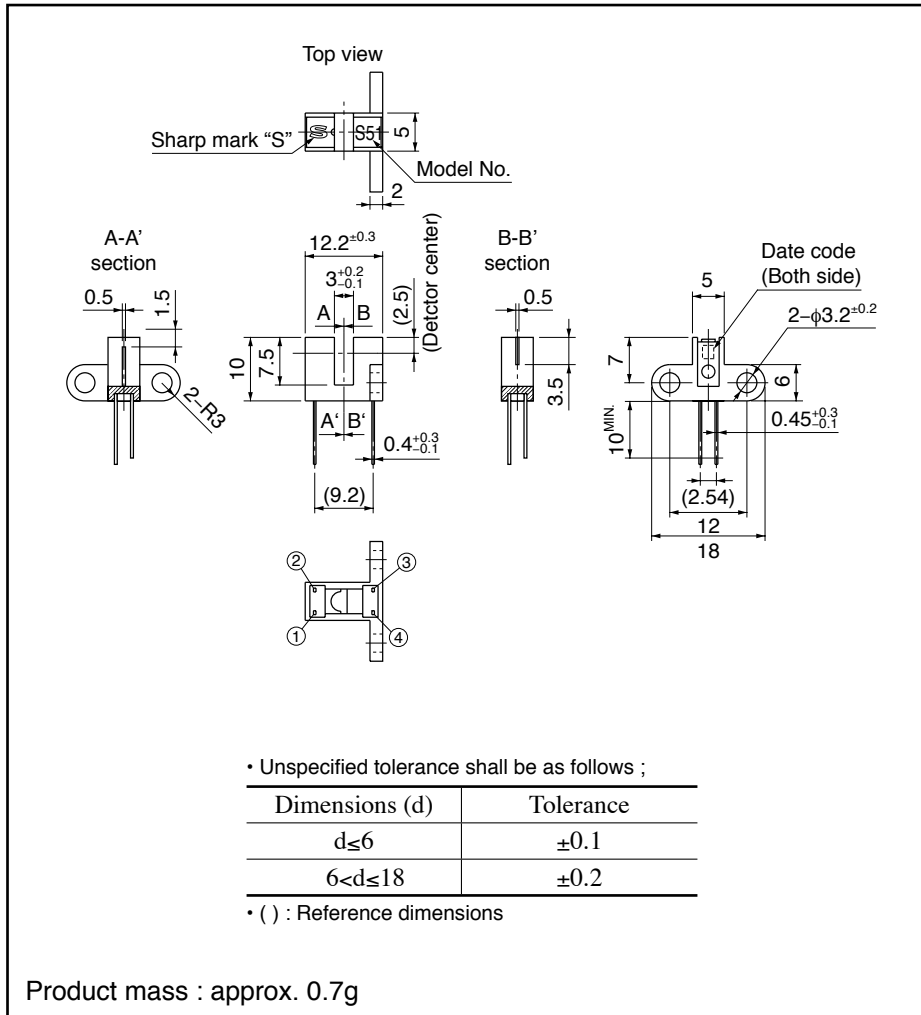

Dip soldering material : Sn-3Ag-0.5Cu

Date code (2 digit)

| 1st digit | | 2nd digit | |
|--------------------|------|---------------------|------|
| Year of production | | Month of production | |
| A.D. | Mark | Month | Mark |
| 2000 | 0 | 1 | 1 |
| 2001 | 1 | 2 | 2 |
| 2002 | 2 | 3 | 3 |
| 2003 | 3 | 4 | 4 |
| 2004 | 4 | 5 | 5 |
| 2005 | 5 | 6 | 6 |
| 2006 | 6 | 7 | 7 |
| 2007 | 7 | 8 | 8 |
| 2008 | 8 | 9 | 9 |
| 2009 | 9 | 10 | X |
| 2010 | 0 | 11 | Y |
| : | : | 12 | Z |

repeats in a 10 year cycle

Country of origin

Japan, Indonesia or Philippines
(Indicated on the packing case)

■ Absolute Maximum Ratings (T_a=25°C)

| Parameter | | Symbol | Rating | Unit |
|--------------------------|--------------------------------|------------------|-------------|------|
| Input | *1 Forward current | I _F | 50 | mA |
| | *1, 2 Peak forward current | I _{FM} | 1 | A |
| | Reverse voltage | V _R | 6 | V |
| | Power dissipation | P | 75 | mW |
| Output | Collector-emitter voltage | V _{CEO} | 35 | V |
| | Emitter-collector voltage | V _{ECO} | 6 | V |
| | Collector current | I _C | 20 | mA |
| | *1 Collector power dissipation | P _C | 75 | mW |
| Operating temperature | | T _{opr} | -25 to +85 | °C |
| Storage temperature | | T _{stg} | -40 to +100 | °C |
| *3 Soldering temperature | | T _{sol} | 260 | °C |

*1 Refer to Fig. 1, 2, 3

*2 Pulse width ≤ 100μs, Duty ratio=0.01

*3 For 5s or less

■ Electro-optical Characteristics (T_a=25°C)

| Parameter | | Symbol | Condition | MIN. | TYP. | MAX. | Unit |
|--------------------------|--------------------------------------|----------------------|---|--|------|------|------|
| Input | Forward voltage | V _F | I _F =20mA | - | 1.25 | 1.4 | V |
| | Peak forward voltage | V _{FM} | I _{FM} =0.5A | - | 3 | 4 | V |
| | Reverse current | I _R | V _R =3V | - | - | 10 | μA |
| Output | Collector dark current | I _{CEO} | V _{CE} =20V | - | 1 | 100 | nA |
| Transfer characteristics | Collector current | I _C | V _{CE} =5V, I _F =20mA | 0.5 | - | 5 | mA |
| | Collector-emitter saturation voltage | V _{CE(sat)} | I _F =40mA, I _C =0.5mA | - | - | 0.4 | V |
| | Response time | Rise time | t _r | V _{CE} =2V, I _C =2mA, R _L =100Ω | - | 3 | 15 |
| Fall time | | t _f | - | | 4 | 20 | |

Fig.1 Forward Current vs. Ambient Temperature

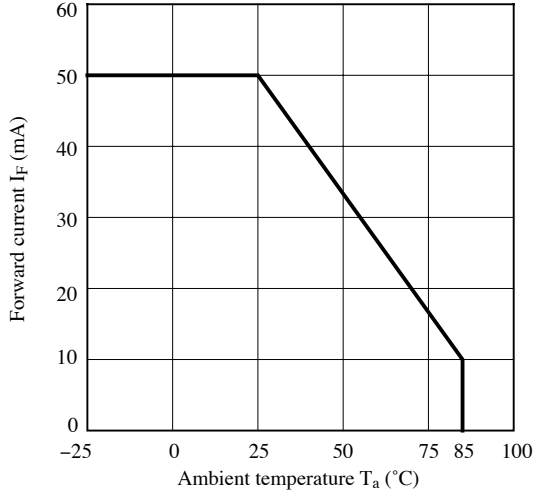

Fig.2 Collector Power Dissipation vs. Ambient Temperature

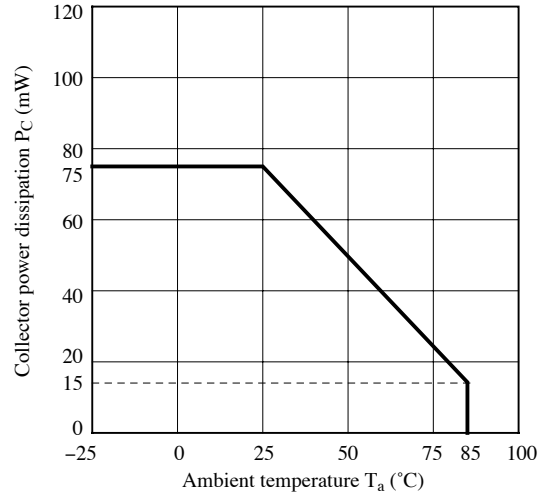

Fig.3 Peak Forward Current vs. Duty Ratio

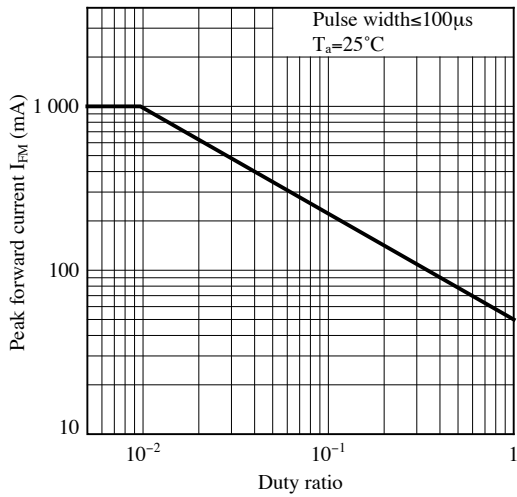

Fig.4 Forward Current vs. Forward Voltage

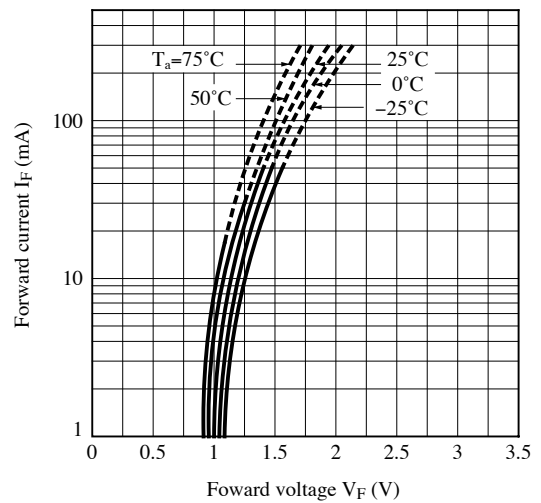

Fig.5 Collector Current vs. Forward Current

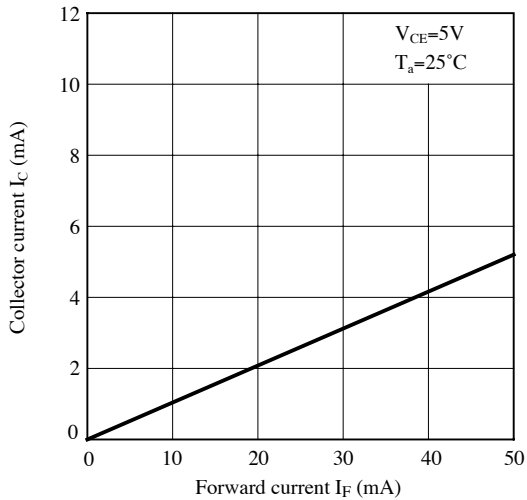

Fig.6 Collector Current vs. Collector-emitter Voltage

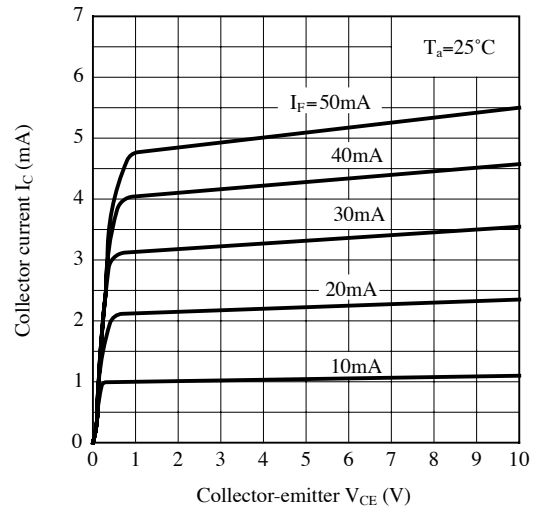

Fig.7 Collector Current vs. Ambient Temperature

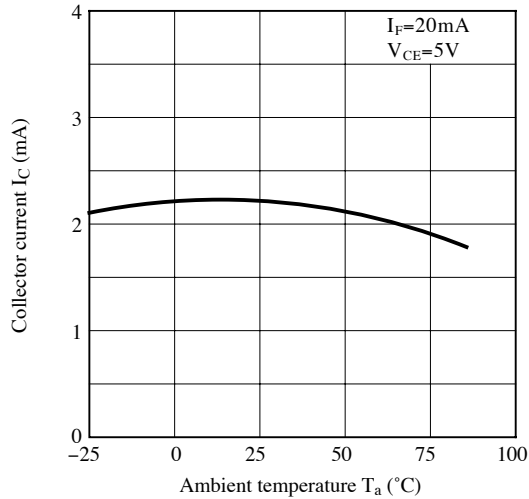

Fig.8 Collector-emitter Saturation Voltage vs. Ambient Temperature

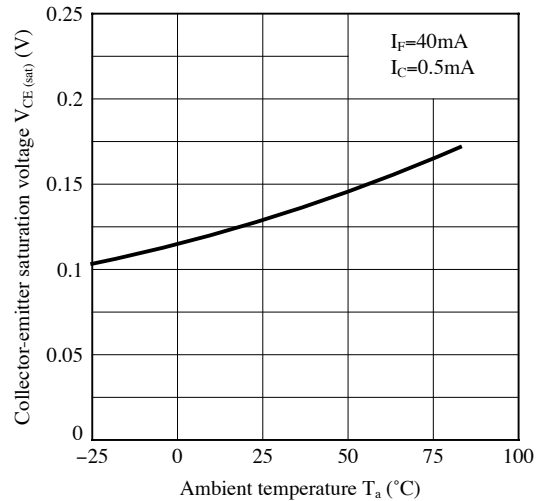

Fig.9 Response Time vs. Load Resistance

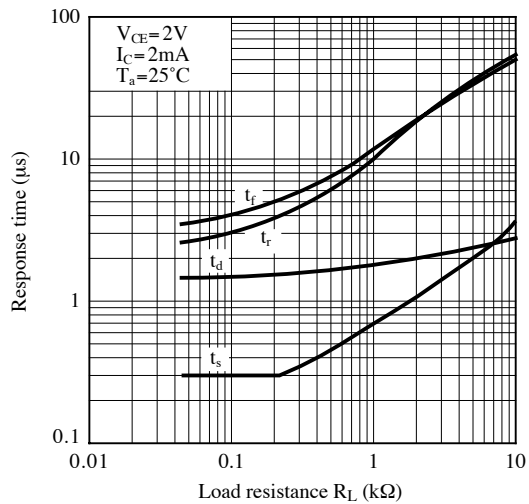

Fig.10 Test Circuit for Response Time

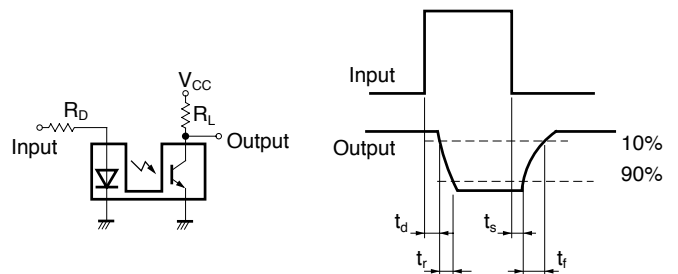

Fig.11 Frequency Response

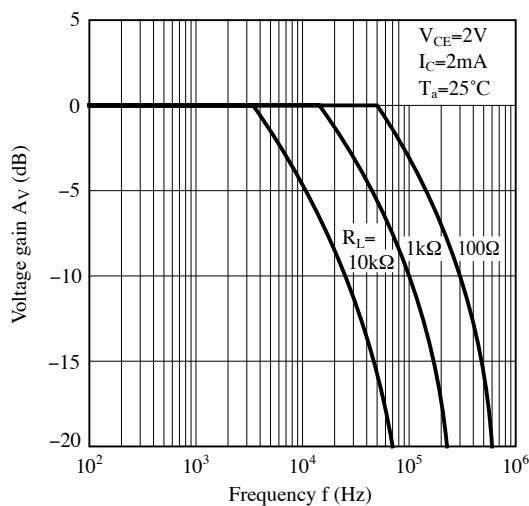

Fig.12 Collector Dark Current vs. Ambient Temperature

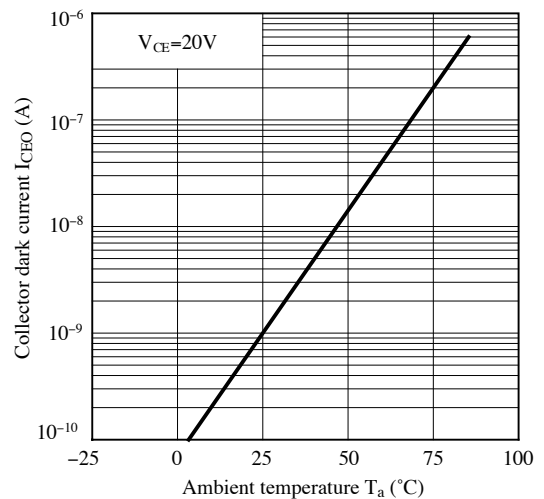
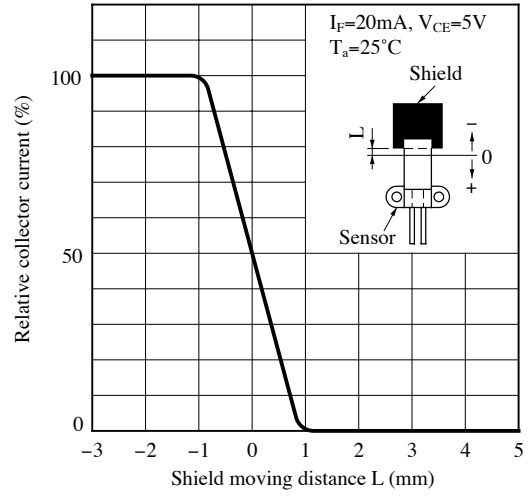
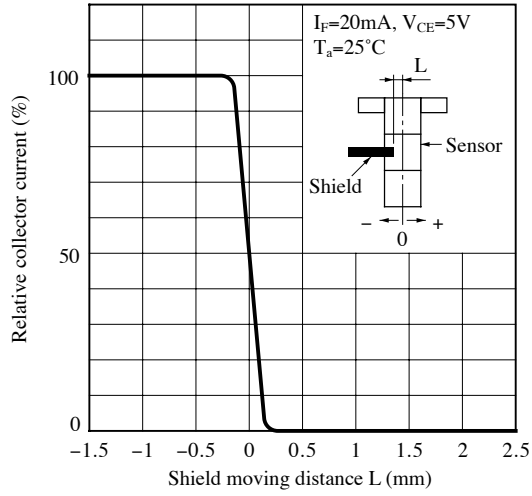

Fig.13 Detecting Position Characteristics (1)

Fig.14 Detecting Position Characteristics (2)



Remarks : Please be aware that all data in the graph are just for reference and not for guarantee.

■ **Design Considerations**

● **Design guide**

1) Prevention of detection error

To prevent photointerrupter from faulty operation caused by external light, do not set the detecting face to the external light.

2) Position of opaque board

Opaque board shall be installed at place 4mm or more from the top of elements.

(Example)

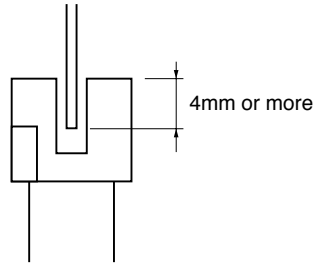

This product is not designed against irradiation and incorporates non-coherent IRED.

● **Degradation**

In general, the emission of the IRED used in photocouplers will degrade over time.

In the case of long term operation, please take the general IRED degradation (50% degradation over 5 years) into the design consideration.

● **Parts**

This product is assembled using the below parts.

• Photodetector (qty. : 1)

| Category | Material | Maximum Sensitivity wavelength (nm) | Sensitivity wavelength (nm) | Response time (μs) |
|-----------------|--------------|-------------------------------------|-----------------------------|--------------------|
| Phototransistor | Silicon (Si) | 800 | 400 to 1 200 | 3 |

• Photo emitter (qty. : 1)

| Category | Material | Maximum light emitting wavelength (nm) | I/O Frequency (MHz) |
|--|-------------------------|--|---------------------|
| Infrared emitting diode (non-coherent) | Gallium arsenide (GaAs) | 950 | 0.3 |

• Material

| | |
|-------------------|----------------------------|
| Case | Lead frame plating |
| Black NORYL resin | Solder dip. (Sn-3Ag-0.5Cu) |

■ Manufacturing Guidelines**● Soldering Method****Flow Soldering:**

Soldering should be completed below 260°C and within 5 s.

Please take care not to let any external force exert on lead pins.

Please don't do soldering with preheating, and please don't do soldering by reflow.

Hand soldering

Hand soldering should be completed within 3 s when the point of solder iron is below 350°C.

Please solder within one time.

Please don't touch the terminals directly by soldering iron.

Soldered product shall treat at normal temperature.

Other notice

Please test the soldering method in actual condition and make sure the soldering works fine, since the impact on the junction between the device and PCB varies depending on the cooling and soldering conditions.

Flux

Some flux, which is used in soldering, may crack the package due to synergistic effect of alcohol in flux and the rise in temperature by heat in soldering. Therefore, in using flux, please make sure that it does not have any influence on appearance and reliability of the photointerrupter.

● Cleaning instructions**Solvent cleaning :**

Solvent temperature should be 45°C or below. Immersion time should be 3 minutes or less.

Ultrasonic cleaning :

The affect to device by ultrasonic cleaning is different by cleaning bath size, ultrasonic power output, cleaning time, PCB size or device mounting condition etc.

Please test it in actual using condition and confirm that doesn't occur any defect before starting the ultrasonic cleaning.

Recommended solvent materials :

Ethyl alcohol, Methyl alcohol and Isopropyl alcohol.

● Presence of ODC

This product shall not contain the following materials.

And they are not used in the production process for this product.

Regulation substances : CFCs, Halon, Carbon tetrachloride, 1.1.1-Trichloroethane (Methylchloroform)

Specific brominated flame retardants such as the PBBOs and PBBs are not used in this product at all.

This product shall not contain the following materials banned in the RoHS Directive (2002/95/EC).

- Lead, Mercury, Cadmium, Hexavalent chromium, Polybrominated biphenyls (PBB), Polybrominated diphenyl ethers (PBDE).

■ Package specification**● Case package****Package materials**

Anti-static plastic bag : Polyethylene

Moltopren : Urethane

Partition : Corrugated fiberboard

Packing case : Corrugated fiberboard

Package method

100 pcs of products shall be packaged in a plastic bag, Ends shall be fixed by stoppers. The bottom of the packing case is covered with moltopren, and the partition is set in the packing case. Each partition should have 1 plastic bag.

The 10 plastic bags containing a product are put in the packing case.

Moltopren should be located after all product are settled (1 packing contains 1 000 pcs).

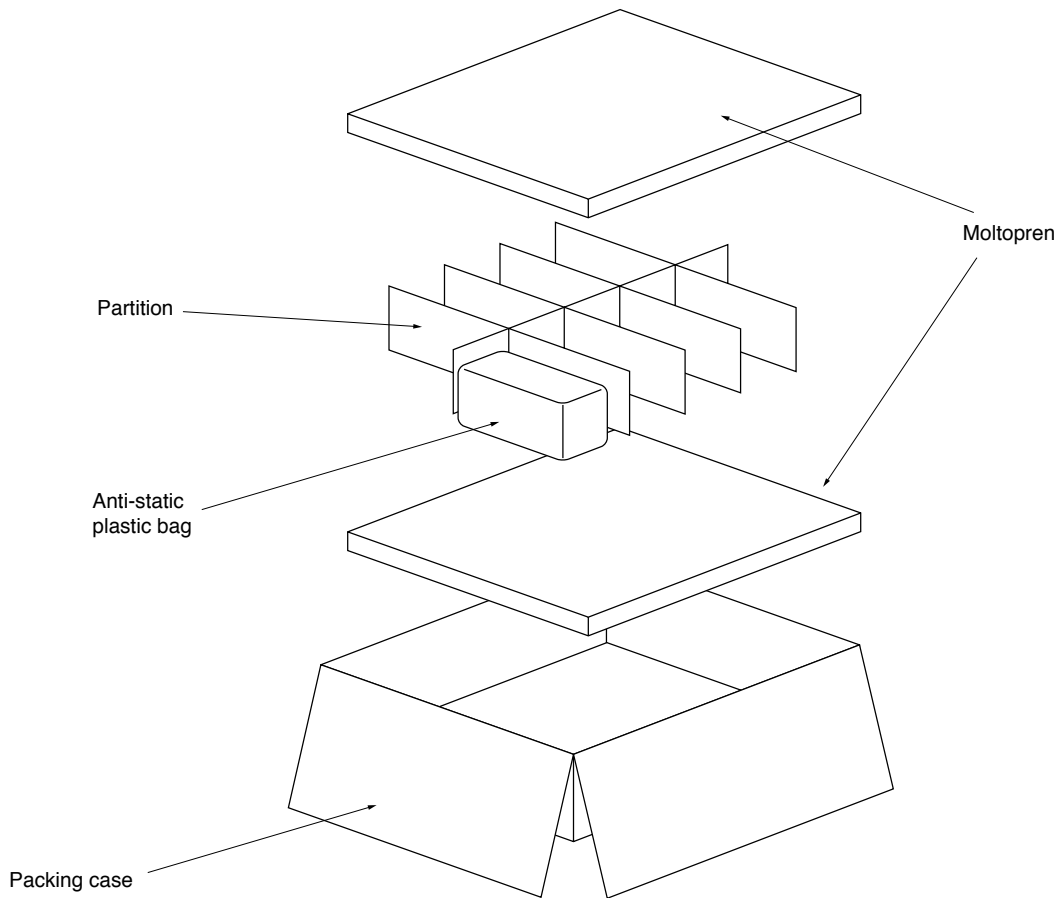
Packing composition

■ Important Notices

· The circuit application examples in this publication are provided to explain representative applications of SHARP devices and are not intended to guarantee any circuit design or license any intellectual property rights. SHARP takes no responsibility for any problems related to any intellectual property right of a third party resulting from the use of SHARP's devices.

· Contact SHARP in order to obtain the latest device specification sheets before using any SHARP device. SHARP reserves the right to make changes in the specifications, characteristics, data, materials, structure, and other contents described herein at any time without notice in order to improve design or reliability. Manufacturing locations are also subject to change without notice.

· Observe the following points when using any devices in this publication. SHARP takes no responsibility for damage caused by improper use of the devices which does not meet the conditions and absolute maximum ratings to be used specified in the relevant specification sheet nor meet the following conditions:

(i) The devices in this publication are designed for use in general electronic equipment designs such as:

- Personal computers
- Office automation equipment
- Telecommunication equipment [terminal]
- Test and measurement equipment
- Industrial control
- Audio visual equipment
- Consumer electronics

(ii) Measures such as fail-safe function and redundant design should be taken to ensure reliability and safety when SHARP devices are used for or in connection

with equipment that requires higher reliability such as:

- Transportation control and safety equipment (i.e., aircraft, trains, automobiles, etc.)
- Traffic signals
- Gas leakage sensor breakers
- Alarm equipment
- Various safety devices, etc.

(iii) SHARP devices shall not be used for or in connection with equipment that requires an extremely high level of reliability and safety such as:

- Space applications
- Telecommunication equipment [trunk lines]
- Nuclear power control equipment
- Medical and other life support equipment (e.g., scuba).

· If the SHARP devices listed in this publication fall within the scope of strategic products described in the Foreign Exchange and Foreign Trade Law of Japan, it is necessary to obtain approval to export such SHARP devices.

· This publication is the proprietary product of SHARP and is copyrighted, with all rights reserved. Under the copyright laws, no part of this publication may be reproduced or transmitted in any form or by any means, electronic or mechanical, for any purpose, in whole or in part, without the express written permission of SHARP. Express written permission is also required before any use of this publication may be made by a third party.

· Contact and consult with a SHARP representative if there are any questions about the contents of this publication.